

**Description**

- 0-10 metre sensing range
- 4 to 384 channels (parallel beams)
- 10 to 1150 cross scanning beams
- Active length of 65 mm to 1920 mm
- Housing length of 160 mm to 1980 mm
- Plug connection
- Automatic or manual adjustment
- Parallel or cross beam scan mode
- Configurable blanking function
- 33x36 mm aluminium housing with T-slot mounting
- High tolerance to hostile environments
- IO-Link communication interface
- 5 pin, IO-Link / push-pull output
- PC software for parameter configuration and diagnostics with optional USB-IO-Link Master 02



The SS 01-IO series is an advanced industrial light curtain system which consists of a self-contained transmitter SST and receiver SSR, which are to be positioned opposite of each other. The light curtains are housed in a sturdy aluminium profile (33 x 36 mm) with T-slot mounting rail, available in lengths ranging from 160 mm to 1980 mm.

The SS 01-IO series is equipped with an IO-Link communication interface which allows a variety of process parameters and settings to be configured and monitored, which includes: automatic or manual gain adjustment, long or short range in automatic mode, light or dark selection, parallel or cross scanning beams, hole detection, smoothing (pre-filtering) function, on/off time delay, one-shot timer, blanking function. The series allows each beam to be individually monitored, which may be used for a wide range of geometrical analysis functions.

The test input in the SST may be used for either disabling or enabling the transmitting power temporarily for test purposes.

The advanced automatic sensitivity adjustment, in Auto Long and Auto Short range mode, ensures that no set up or adjustments are required. The signal level of each individual channel is adjusted automatically, which compensates for misalignment and contamination during operation. The transmitter and receiver are electrically synchronised by wire connection. The system is intended for static applications.

Both the transmitter and receiver units are protected against reverse polarity of power supplies, test input and output signals. The output is also protected against short circuit and inductive loads.

Technical Data						
		SST			SSR	
Supply voltage		12-30 V dc				
Current consumption		100 mA			50 mA	
Output (Q <sub>1</sub> )		-			Push / Pull	
Output rating		-			100 mA	
Short circuit protected		-			Yes	
Reverse polarity protected		-			Yes	
Light source		Infrared (880 nm)			-	
Channel spacing		5 mm	10 mm	20 mm	5 mm	10 mm 20 mm
Number of channels (diodes per detector)		16 ... 384	8 ... 192	4 ... 96	16 ... 384	8 ... 192 4 ... 96
Number of beams		Parallel	16 ... 384	8 ... 192	4 ... 96	16 ... 384 8 ... 192 4 ... 96
		Cross	46 ... 1150	22 ... 574	10 ... 286	46 ... 1150 22 ... 574 10 ... 286
Active length		65 ... 1920 mm				
Housing length		160 ... 1980 mm				
Max. response time		Parallel / Cross	-			(N x 120 µs) + 2 ms
		Parallel	-			6,6 ... 48,1 ms 6,6 ... 25,0 ms 6,6 ... 13,5 ms
		Cross	-			6,6 ... 140,0 ms 6,6 ... 70,9 ms 6,6 ... 36,3 ms
Power on indicator		Green LED				
Output indicator		-			Yellow LED	
System status indicator		-			Red LED	
Blanking function		-			Configurable	
Housing dimensions (w x d)		33 x 36 mm				
Housing material		Aluminium (black sealed anodised)				
		CoPET				
Connection Cable, PVC Ø 5,9 mm		0,5 m cable with 5 pin, M12 plug			0,5 m cable with 5 pin, M12 plug	

Note: "N" is equal to the number of beams (parallel or crossed).

Environmental Data		SST	SSR
Vibration		10-55 Hz, 0,5 mm	
Shock		30 g	
Light immunity @ 5° incidence		-	100 000 lux
Temperature, operation		-30 to +60 °C	
Temperature, storage		-40 to +80 °C	
Sealing class		IP 67	
Approvals		CE UK CA	

Available Types								
	Housing Length	Active Length	Number of Channels	Number of Beams Parallel / Cross	Channel Spacing	Connection	0.5 m cable with 5 pin, M12 plug	Range
						Output	Order Reference	
Transmitter	160 mm	80 mm	16	16 / 46	5 mm	-	SST 01-10-016-016-05-H-1D1-0.5-J5	10 m
	220 mm	160 mm	32	32 / 94			SST 01-10-022-032-05-H-1D1-0.5-J5	
	300 mm	240 mm	48	48 / 142			SST 01-10-030-048-05-H-1D1-0.5-J5	
	380 mm	320 mm	64	64 / 190			SST 01-10-038-064-05-H-1D1-0.5-J5	
	460 mm	400 mm	80	80 / 238			SST 01-10-046-080-05-H-1D1-0.5-J5	
	540 mm	480 mm	96	96 / 286			SST 01-10-054-096-05-H-1D1-0.5-J5	
	620 mm	560 mm	112	112 / 334			SST 01-10-062-112-05-H-1D1-0.5-J5	
	700 mm	640 mm	128	128 / 382			SST 01-10-070-128-05-H-1D1-0.5-J5	
	860 mm	800 mm	160	160 / 478			SST 01-10-086-160-05-H-1D1-0.5-J5	
	1020 mm	960 mm	192	192 / 574			SST 01-10-102-192-05-H-1D1-0.5-J5	
	1180 mm	1120 mm	224	224 / 670			SST 01-10-118-224-05-H-1D1-0.5-J5	
	1340 mm	1280 mm	256	256 / 766			SST 01-10-134-256-05-H-1D1-0.5-J5	
	1500 mm	1440 mm	288	288 / 862			SST 01-10-150-288-05-H-1D1-0.5-J5	
	1660 mm	1600 mm	320	320 / 958			SST 01-10-166-320-05-H-1D1-0.5-J5	
	1820 mm	1760 mm	352	352 / 1054			SST 01-10-182-352-05-H-1D1-0.5-J5	
	1980 mm	1920 mm	384	384 / 1150	SST 01-10-198-384-05-H-1D1-0.5-J5			
	160 mm	75 mm	8	8 / 22	10 mm	-	SST 01-10-016-008-10-H-1D1-0.5-J5	
	220 mm	155 mm	16	16 / 46			SST 01-10-022-016-10-H-1D1-0.5-J5	
	300 mm	235 mm	24	24 / 70			SST 01-10-030-024-10-H-1D1-0.5-J5	
	380 mm	315 mm	32	32 / 94			SST 01-10-038-032-10-H-1D1-0.5-J5	
	460 mm	395 mm	40	40 / 118			SST 01-10-046-040-10-H-1D1-0.5-J5	
	540 mm	475 mm	48	48 / 142			SST 01-10-054-048-10-H-1D1-0.5-J5	
	620 mm	555 mm	56	56 / 166			SST 01-10-062-056-10-H-1D1-0.5-J5	
	700 mm	635 mm	64	64 / 190			SST 01-10-070-064-10-H-1D1-0.5-J5	
	860 mm	795 mm	80	80 / 238			SST 01-10-086-080-10-H-1D1-0.5-J5	
	1020 mm	955 mm	96	96 / 286			SST 01-10-102-096-10-H-1D1-0.5-J5	
	1180 mm	1115 mm	112	112 / 334			SST 01-10-118-112-10-H-1D1-0.5-J5	
	1340 mm	1275 mm	128	128 / 382			SST 01-10-134-128-10-H-1D1-0.5-J5	
	1500 mm	1435 mm	144	144 / 430			SST 01-10-150-144-10-H-1D1-0.5-J5	
	1660 mm	1595 mm	160	160 / 478			SST 01-10-166-160-10-H-1D1-0.5-J5	
	1820 mm	1755 mm	176	176 / 526			SST 01-10-182-176-10-H-1D1-0.5-J5	
	1980 mm	1915 mm	192	192 / 574	SST 01-10-198-192-10-H-1D1-0.5-J5			
	160 mm	65 mm	4	4 / 10	20 mm	-	SST 01-10-016-004-20-H-1D1-0.5-J5	
	220 mm	145 mm	8	8 / 22			SST 01-10-022-008-20-H-1D1-0.5-J5	
	300 mm	225 mm	12	12 / 34			SST 01-10-030-012-20-H-1D1-0.5-J5	
	380 mm	305 mm	16	16 / 46			SST 01-10-038-016-20-H-1D1-0.5-J5	
	460 mm	385 mm	20	20 / 58			SST 01-10-046-020-20-H-1D1-0.5-J5	
	540 mm	465 mm	24	24 / 70			SST 01-10-054-024-20-H-1D1-0.5-J5	
	620 mm	545 mm	28	28 / 82			SST 01-10-062-028-20-H-1D1-0.5-J5	
	700 mm	625 mm	32	32 / 94			SST 01-10-070-032-20-H-1D1-0.5-J5	
	860 mm	785 mm	40	40 / 118			SST 01-10-086-040-20-H-1D1-0.5-J5	
	1020 mm	945 mm	48	48 / 142			SST 01-10-102-048-20-H-1D1-0.5-J5	
	1180 mm	1105 mm	56	56 / 166			SST 01-10-118-056-20-H-1D1-0.5-J5	
	1340 mm	1265 mm	64	64 / 190			SST 01-10-134-064-20-H-1D1-0.5-J5	
	1500 mm	1425 mm	72	72 / 214			SST 01-10-150-072-20-H-1D1-0.5-J5	
1660 mm	1585 mm	80	80 / 238	SST 01-10-166-080-20-H-1D1-0.5-J5				
1820 mm	1745 mm	88	88 / 262	SST 01-10-182-088-20-H-1D1-0.5-J5				
1980 mm	1905 mm	96	96 / 286	SST 01-10-198-096-20-H-1D1-0.5-J5				

Note: Special lengths are available upon request.

Available Types

	Housing Length	Active Length	Number of Channels	Number of Beams Parallel / Cross	Channel Spacing	Connection Output	0.5 m cable with 5 pin, M12 plug	Range		
							Order Reference			
Receiver	160 mm	80 mm	16	16 / 46	5 mm	Push / Pull	SSR 01-10-016-016-05-H-IO-0.5-J5	1-10 m		
	220 mm	160 mm	32	32 / 94			SSR 01-10-022-032-05-H-IO-0.5-J5			
	300 mm	240 mm	48	48 / 142			SSR 01-10-030-048-05-H-IO-0.5-J5			
	380 mm	320 mm	64	64 / 190			SSR 01-10-038-064-05-H-IO-0.5-J5			
	460 mm	400 mm	80	80 / 238			SSR 01-10-046-080-05-H-IO-0.5-J5			
	540 mm	480 mm	96	96 / 286			SSR 01-10-054-096-05-H-IO-0.5-J5			
	620 mm	560 mm	112	112 / 334			SSR 01-10-062-112-05-H-IO-0.5-J5			
	700 mm	640 mm	128	128 / 382			SSR 01-10-070-128-05-H-IO-0.5-J5			
	860 mm	800 mm	160	160 / 478			SSR 01-10-086-160-05-H-IO-0.5-J5			
	1020 mm	960 mm	192	192 / 574			SSR 01-10-102-192-05-H-IO-0.5-J5			
	1180 mm	1120 mm	224	224 / 670			SSR 01-10-118-224-05-H-IO-0.5-J5			
	1340 mm	1280 mm	256	256 / 766			SSR 01-10-134-256-05-H-IO-0.5-J5			
	1500 mm	1440 mm	288	288 / 862			SSR 01-10-150-288-05-H-IO-0.5-J5			
	1660 mm	1600 mm	320	320 / 958			SSR 01-10-166-320-05-H-IO-0.5-J5			
	1820 mm	1760 mm	352	352 / 1054			SSR 01-10-182-352-05-H-IO-0.5-J5			
	1980 mm	1920 mm	384	384 / 1150			SSR 01-10-198-384-05-H-IO-0.5-J5			
	160 mm	75 mm	8	8 / 22			10 mm		Push / Pull	SSR 01-10-016-008-10-H-IO-0.5-J5
	220 mm	155 mm	16	16 / 46						SSR 01-10-022-016-10-H-IO-0.5-J5
	300 mm	235 mm	24	24 / 70	SSR 01-10-030-024-10-H-IO-0.5-J5					
	380 mm	315 mm	32	32 / 94	SSR 01-10-038-032-10-H-IO-0.5-J5					
	460 mm	395 mm	40	40 / 118	SSR 01-10-046-040-10-H-IO-0.5-J5					
	540 mm	475 mm	48	48 / 142	SSR 01-10-054-048-10-H-IO-0.5-J5					
	620 mm	555 mm	56	56 / 166	SSR 01-10-062-056-10-H-IO-0.5-J5					
	700 mm	635 mm	64	64 / 190	SSR 01-10-070-064-10-H-IO-0.5-J5					
	860 mm	795 mm	80	80 / 238	SSR 01-10-086-080-10-H-IO-0.5-J5					
	1020 mm	955 mm	96	96 / 286	SSR 01-10-102-096-10-H-IO-0.5-J5					
	1180 mm	1115 mm	112	112 / 334	SSR 01-10-118-112-10-H-IO-0.5-J5					
	1340 mm	1275 mm	128	128 / 382	SSR 01-10-134-128-10-H-IO-0.5-J5					
	1500 mm	1435 mm	144	144 / 430	SSR 01-10-150-144-10-H-IO-0.5-J5					
	1660 mm	1595 mm	160	160 / 478	SSR 01-10-166-160-10-H-IO-0.5-J5					
	1820 mm	1755 mm	176	176 / 526	SSR 01-10-182-176-10-H-IO-0.5-J5					
	1980 mm	1915 mm	192	192 / 574	SSR 01-10-198-192-10-H-IO-0.5-J5					
	160 mm	65 mm	4	4 / 10	20 mm	Push / Pull				SSR 01-10-016-004-20-H-IO-0.5-J5
	220 mm	145 mm	8	8 / 22						SSR 01-10-022-008-20-H-IO-0.5-J5
	300 mm	225 mm	12	12 / 34			SSR 01-10-030-012-20-H-IO-0.5-J5			
	380 mm	305 mm	16	16 / 46			SSR 01-10-038-016-20-H-IO-0.5-J5			
	460 mm	385 mm	20	20 / 58			SSR 01-10-046-020-20-H-IO-0.5-J5			
	540 mm	465 mm	24	24 / 70			SSR 01-10-054-024-20-H-IO-0.5-J5			
	620 mm	545 mm	28	28 / 82			SSR 01-10-062-028-20-H-IO-0.5-J5			
	700 mm	625 mm	32	32 / 94			SSR 01-10-070-032-20-H-IO-0.5-J5			
	860 mm	785 mm	40	40 / 118			SSR 01-10-086-040-20-H-IO-0.5-J5			
	1020 mm	945 mm	48	48 / 142			SSR 01-10-102-048-20-H-IO-0.5-J5			
	1180 mm	1105 mm	56	56 / 166			SSR 01-10-118-056-20-H-IO-0.5-J5			
	1340 mm	1265 mm	64	64 / 190			SSR 01-10-134-064-20-H-IO-0.5-J5			
	1500 mm	1425 mm	72	72 / 214			SSR 01-10-150-072-20-H-IO-0.5-J5			
1660 mm	1585 mm	80	80 / 238	SSR 01-10-166-080-20-H-IO-0.5-J5						
1820 mm	1745 mm	88	88 / 262	SSR 01-10-182-088-20-H-IO-0.5-J5						
1980 mm	1905 mm	96	96 / 286	SSR 01-10-198-096-20-H-IO-0.5-J5						

Note: Special lengths are available upon request.

**Connections**

	M12 Plug / Cable	
	SST	SSR
Supply +	Pin 1 / Brown	Pin 1 / Brown
Supply -	Pin 3 / Blue	Pin 3 / Blue
Common sync 1	Pin 2 / White	Pin 2 / White
Common sync 2	Pin 5 / Grey	Pin 5 / Grey
Test input	Pin 4 / Black	-
IO-Link	-	Pin 4 / Black

**5 pin, M12**

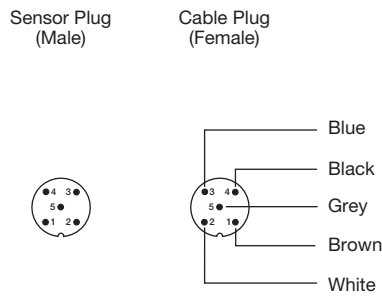

**Wiring Diagrams**

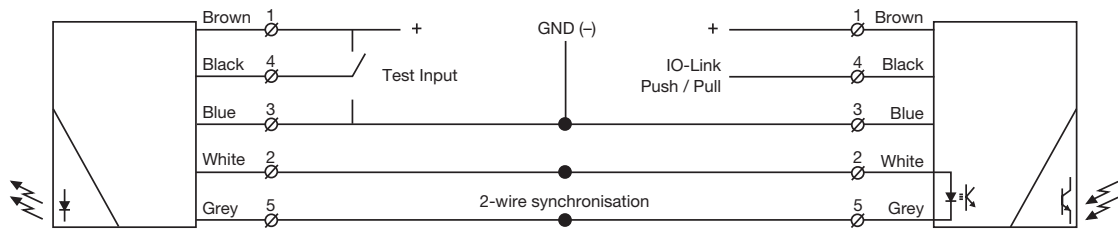

**SST 01**  
Connect black test input wire to + or - to disable SST

**SSR 01-10**

Dimensions and Descriptions

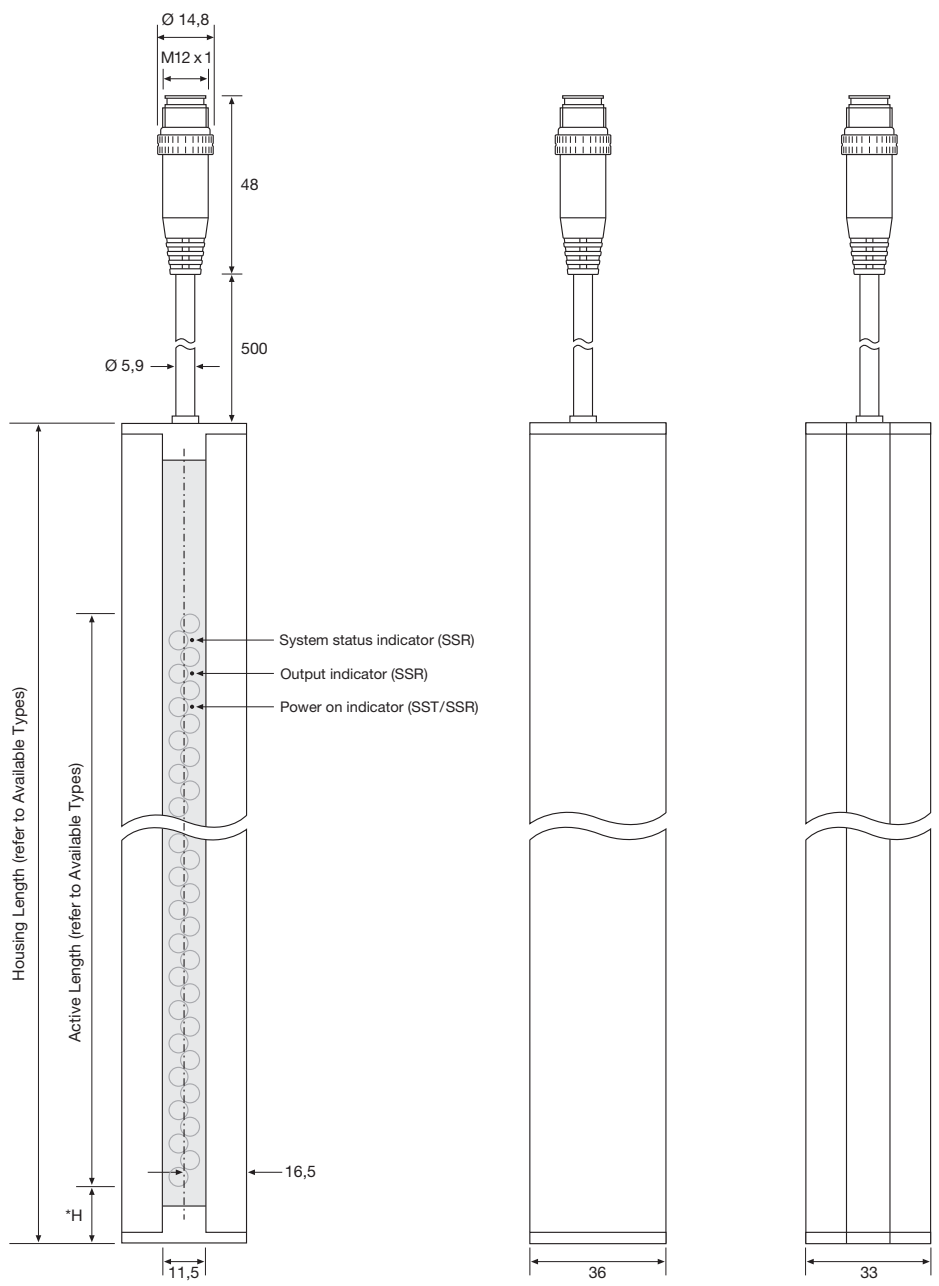

\*H =  
 5 mm channel spacing: 13,8 mm  
 10/20 mm channel spacing: 15,8 mm

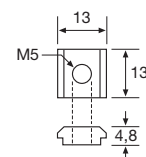
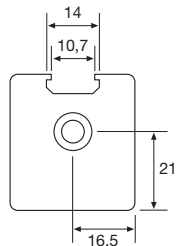

**T-Slot Mounting Fixture**  
 Stainless Steel AISI 304  
 (2 units included)

(Units in mm)

Beam Patterns

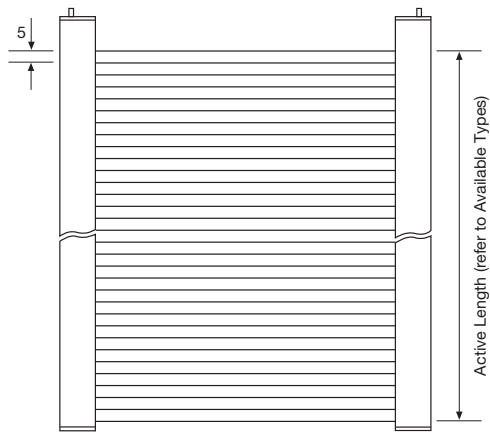

Parallel Beams

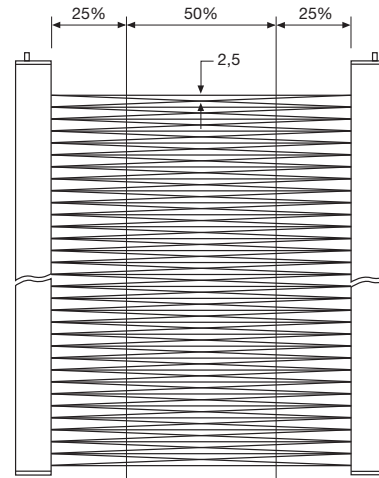

Cross Beams

5 mm channel spacing

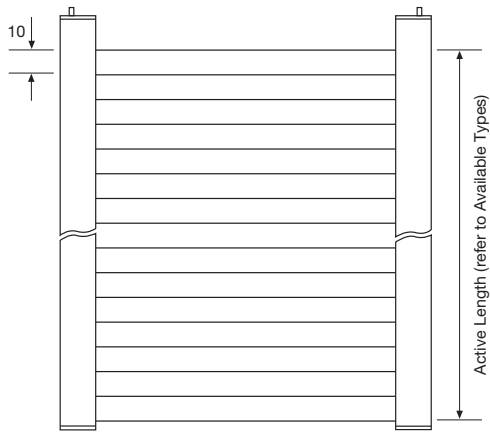

Parallel Beams

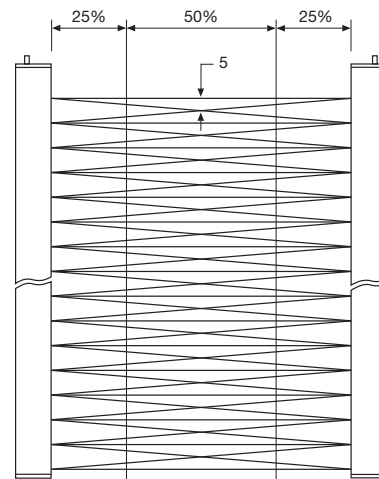

Cross Beams

10 mm channel spacing

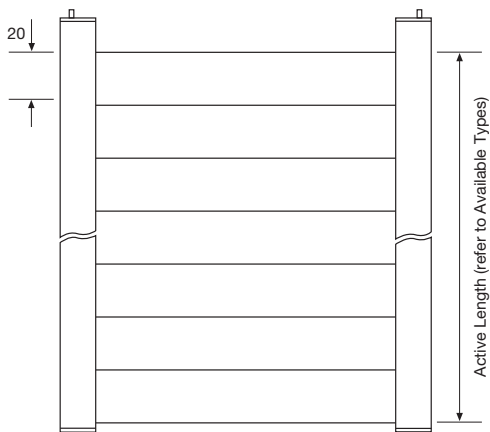

Parallel Beams

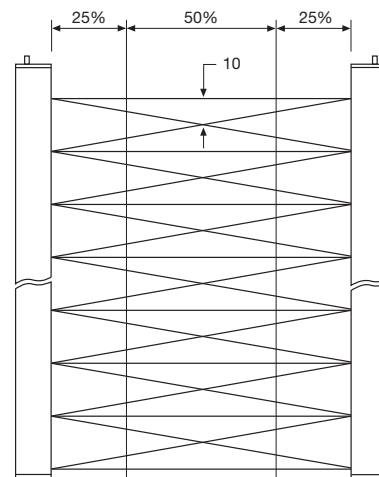

Cross Beams

20 mm channel spacing

(Units in mm)

Sensing Characteristics

Parallel Displacement

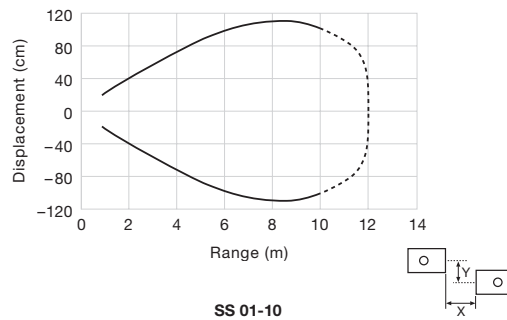

SS 01-10

Mounting Bracket

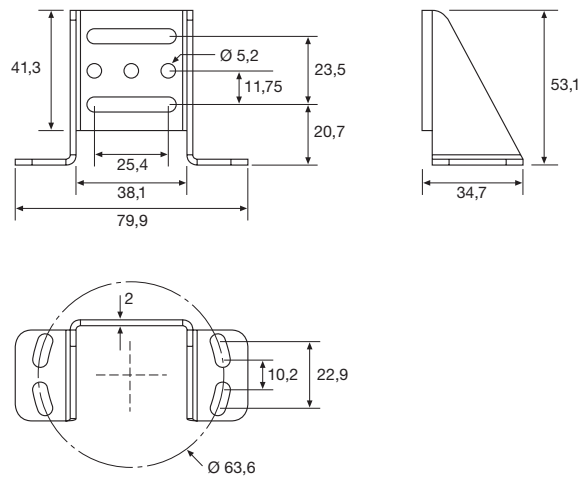

TR SS53-80 LU  
Stainless Steel AISI 304  
(to be ordered separately)

(Units in mm)

SpaceScan PC Programming and Monitoring

General Setup

	Name	Description	Value Range
1	Range	Automatic gain adjustment, short range, low excess gain	Auto Short
		Automatic gain adjustment, long range, high excess gain	Auto Long
		Manual gain adjustment	Manual
2	Range (Manual mode)	Select range (gain) level	0-100(%)
3	Scan Model	Select scan mode	Parallel / Crossed beam scanning
4	Hole Detection	Invert the status of all beams	True / False

USB-IO Link Master 02 PC Software Screenshot

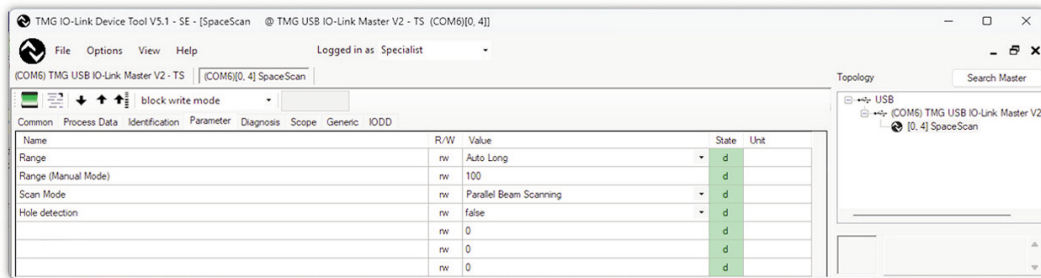



SpaceScan PC Programming and Monitoring

SIO / Digital Output

	Name	Description	Value Range
1	Light Operated	Select between light or dark operation	True / False
2	Minimum Size of Coherent Area	Specifies the maximum size of objects that shall be ignored	Beam number
3	On-Delay	On delay time between the expression becomes true and the output is switched	0.0 – 10.0 s
4	Off-Delay	Off delay time between the expression becomes false and the output is switched	0.0 – 10.0 s
5	One Shot Time	Select duration the output be active when switching from not active to active	0.0 – 60.0 s
6	Force Set Enable	Allows the user to set the value of the digital output	True / False
7	Forced On	Output is set to high or low	True / False

Channel 1

	Name	Description	Value Range
1	Light Operated	Select between light or dark operation	True / False
2	Minimum Size of Coherent Area	Specifies the maximum size of objects that shall be ignored	Beam number
3	On-Delay	On delay time between the expression becomes true and the output is switched	0.0 – 10.0 s
4	Off-Delay	Off delay time between the expression becomes false and the output is switched	0.0 – 10.0 s
5	One Shot Time	Select duration the output be active when switching from not active to active	0.0 – 60.0 s
6	Force Set Enable	Allows the user to set the value of the channel 1	True / False
7	Forced On	Channel 1 is set to high or low	True / False

USB-IO Link Master 02 PC Software Screenshot

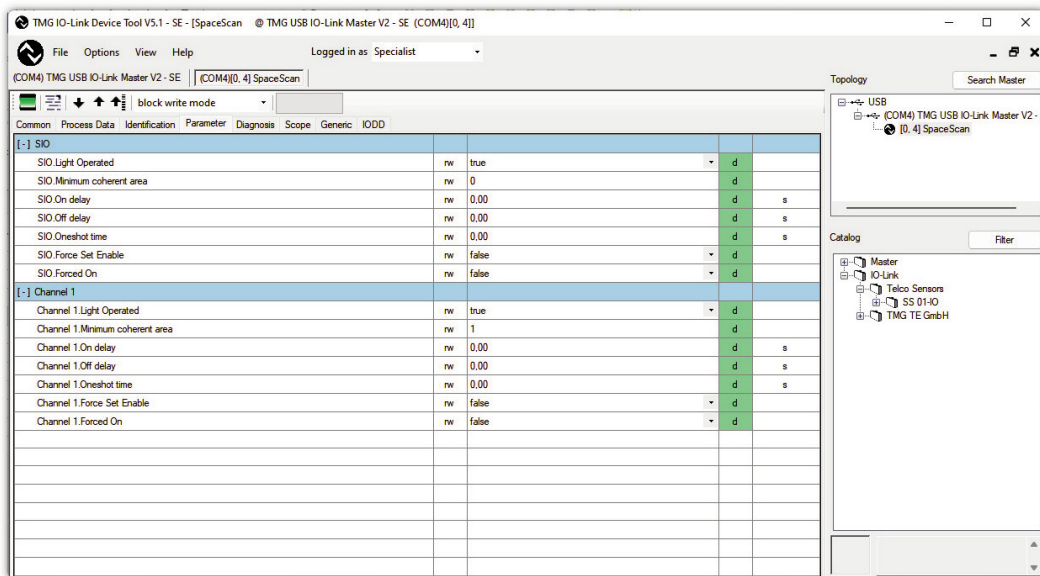

SpaceScan PC Programming and Monitoring

Blanking

	Name	Description	Value Range
1	Measure Blanking from Light Curtain	Obstructed areas are read from light curtain and written as text in blanking text box Blanked beams can be seen in values for Write Blanking to Light Curtain after upload	True (write only)
2	Blanking [1]	Blanking value for first set of 8 beams in a binary value	0 – 255 (0-8 beams blanked)
3	Blanking [2]	Blanking value for second set of 8 beams in a binary value	0 – 255 (0-8 beams blanked)
4	Blanking [3]	Blanking value for third set of 8 beams in a binary value	0 – 255 (0-8 beams blanked)
5	Blanking [4]	Blanking value for fourth set of 8 beams in a binary value	0 – 255 (0-8 beams blanked)
	...		
48	Blanking [48]	Blanking value for beam 377 to 384	0 – 255 (0-8 beams blanked)

USB-IO Link Master 02 PC Software Screenshot

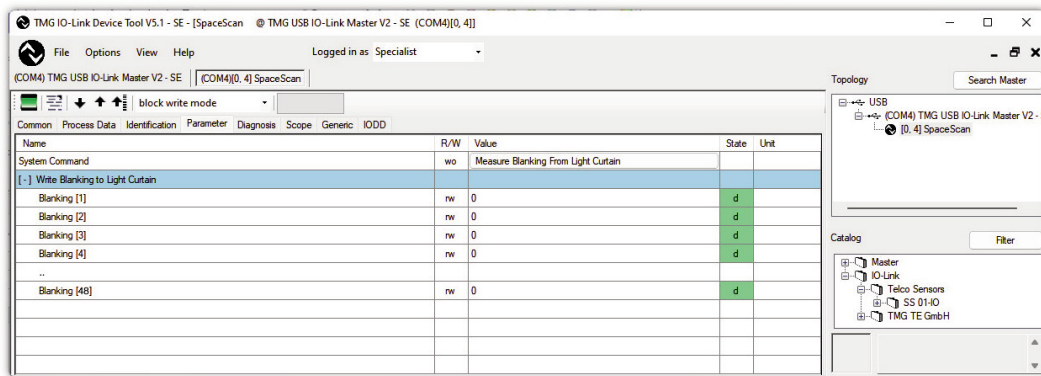

SpaceScan PC Programming and Monitoring

Process Data

	Name	Description	Value Range
1	SIO	Indicates status of SIO output	True / False
2	Channel 1	Indicates status of channel 1	True / False
3	Short Range	Indicates if short range is selected	True / False
4	Crossed Beam Scanning	Indicates if crossed beams mode is selected	True / False
5	Error	Indicates if there is an error (low voltage or synchronisation failure)	True / False
6	Contiguously Blocked Beams	Indicates the number of the maximum contiguously blocked beams	0
7	Beams 1 to 8	Value for first set of 8 beams in a binary value	0 – 255
8	Beams 9 to 16	Value for second set of 8 beams in a binary value	0 – 255
9	Beams 17 to 24	Value for third set of 8 beams in a binary value	0 – 255
...			
46	Beams 312 to 320	Value for beams 312 to 320	0 – 255

Note: 320 is the maximum number of beams that can be displayed in the Process Data tab due to IO Link limitation.

USB-IO Link Master 02 PC Software Screenshot

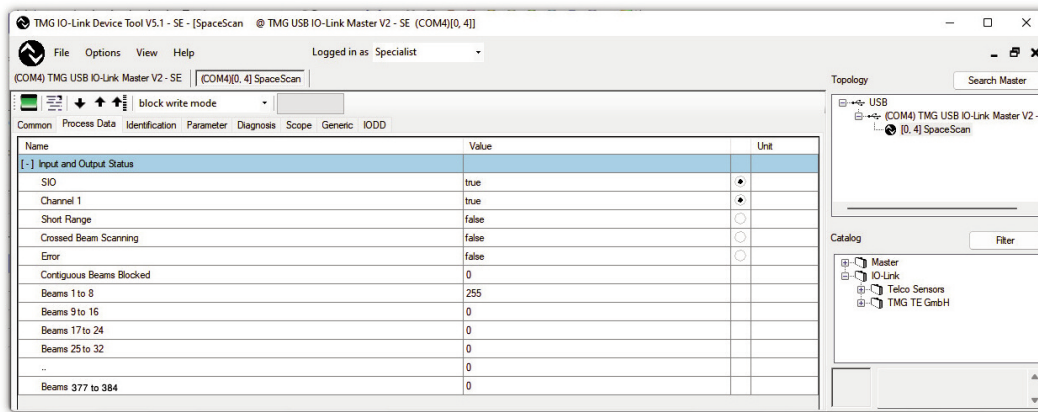

Telco reserves the right to change specifications without notice.